

RIPON HIGH SCHOOL

Note Pad Holder

DRN BY: Mr. Patterson	Scale: NTS
Date:	Fig.:
Page:	Per.
Assig. #	

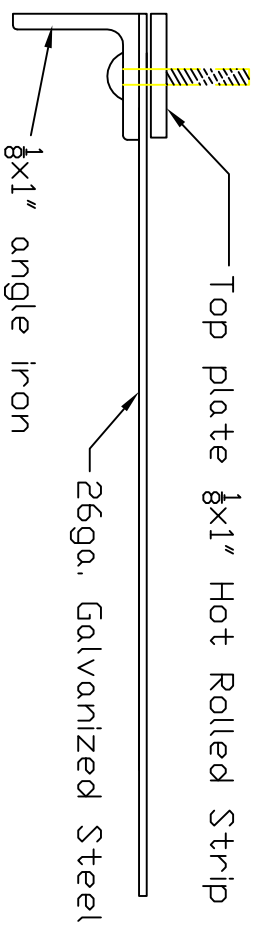
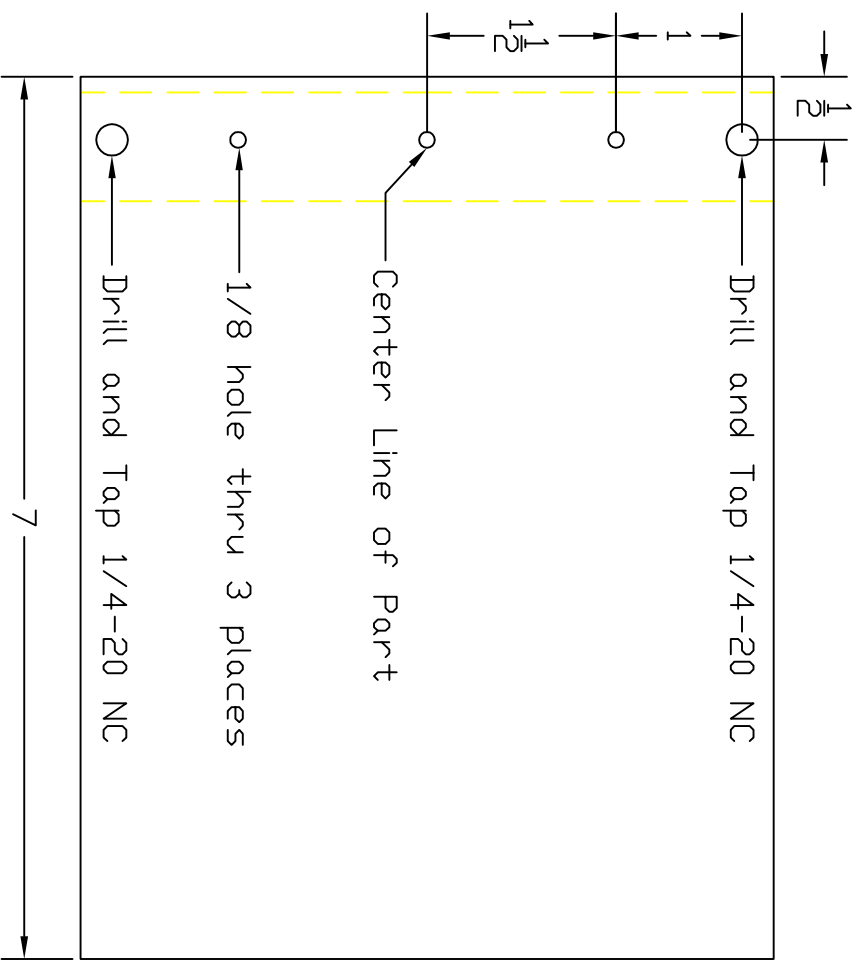

- Materials & Cut list
- 1- 5 1/2"x7" 26ga galv. sheetmetal
 - 1- 1/8"x1 hot rolled strip
 - 1- 1/8"x1"x1" angle iron
 - 2- 1"x1/4"-20 NC pan head screw
 - 2- 1/4" lock washer
 - 2- 1/4"-20NC wing nut

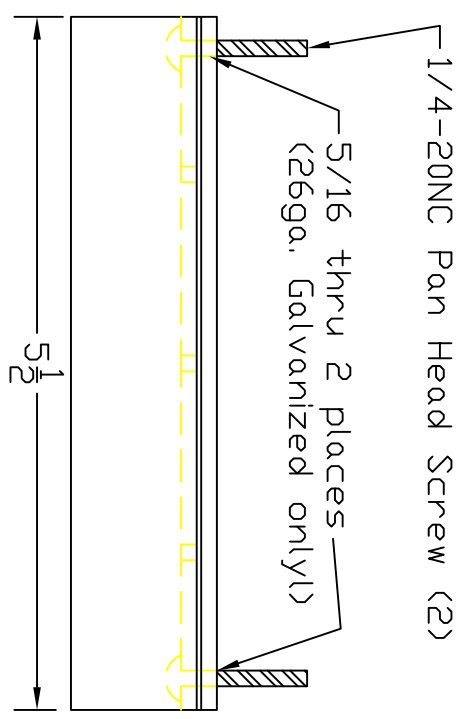

RIPON HIGH SCHOOL

Note Pad Holder-Angle iron base

DRN BY: Mr. Patterson	Scale: NTS
Date:	Fig.:
Page:	Per.
Assig. #	

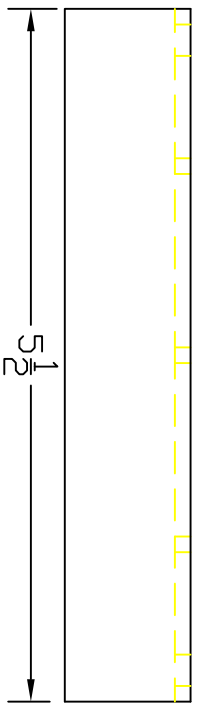
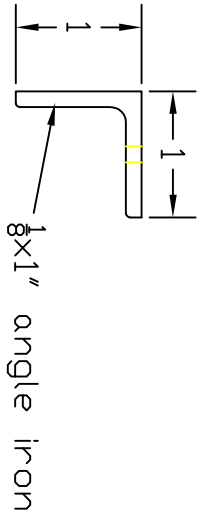
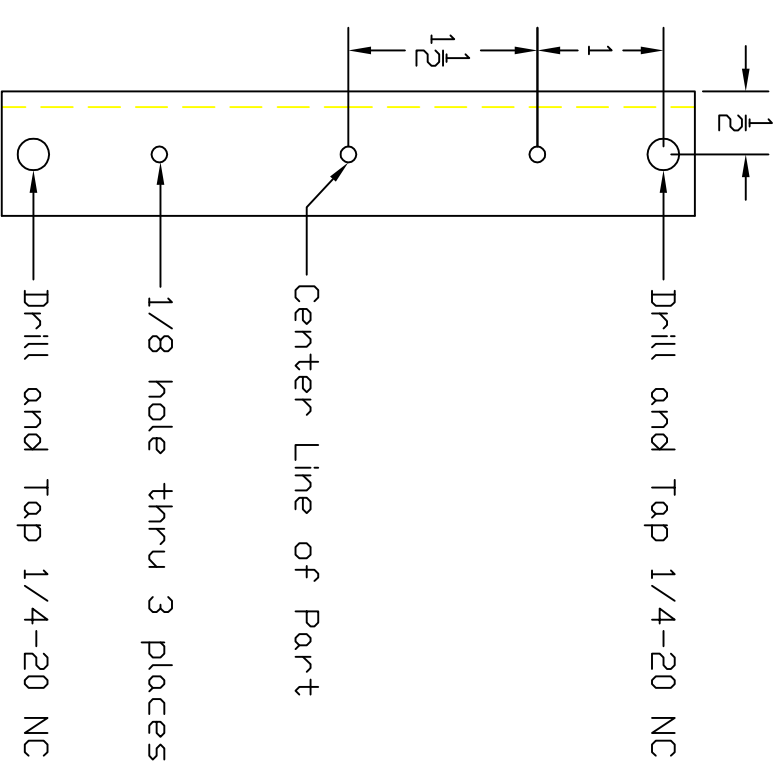

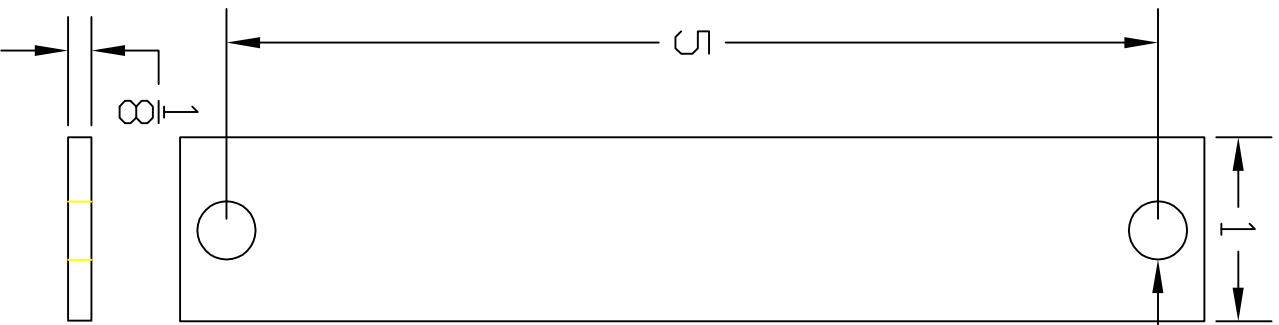

5/16" hole thru 2 plcs

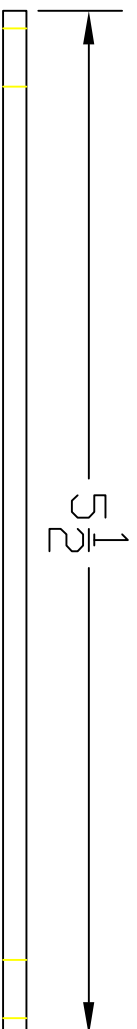

Const Tech 1

Note pad holddown

March 2, 2009

RIPON HIGH SCHOOL

Note Pad Holder-Sheet metal

DRN BY: Mr. Patterson	Scale: NTS
Date:	Fig.:
Page:	Per.
Assig. #	

